

# AUTOMATIC SLIDING DOOR OPERATOR



**DUALCORE**, the new operator for sliding doors suits any type of installation, even the heaviest one, it stands out for modular design, mechanic and electronic features that create a flexible, functional and compact sliding door system, easy to install and provided with most advanced technological solutions present in the market.  
Available models: LH100 with payload 2 X 100 Kg. LH140 with payload 2 X 140 Kg and RD100, with technology suitable for escape routes.

- Structure in aluminum with removable cover, provided by a system that keeps it open during maintenance and cleaning operations
- New carriage with two rollers, increased diameter, adjustable heights
- Parameters setting directly on board by using display with push buttons. Programming Main Key for firmware upgrade and custom made solutions
- Expansion board for additional features like LAN connection with IP address or connection to smartphone and tablet in Bluetooth mode

- Option to connect wireless logic selectors
- Latest generation of control board, with integrated switching, that grants energy saving reduced weight and size, more accelerations compared to classic toroidal transformer.
- **DUALCORE** technology with double microprocessor, first one upgradable and customizable, used to manage logic parameters; second one used as safety processor with "sealed" firmware, all protected from a double self-extinguishing plastic cover
- Bluetooth technology is already available within the operator and will be programmable from Bluetooth devices shortly.

Development, testing and production of **DUALCORE**, as for all **SESAMO** products, according international standards ISO 9001.

# DUALCORE AUTOMATIC SLIDE DOOR OPERATOR

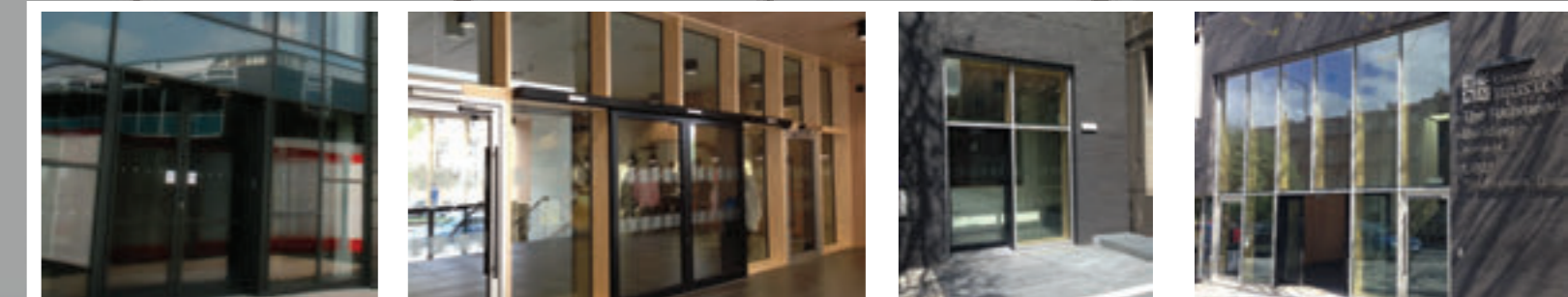

Prosale Limited  
Unit 30 The Glenmore Centre  
Marconi Drive  
Waterwells Business Park  
Quedgeley, Glos.  
GL2 2AP  
Tel: 0845 0945 636  
[www.prosaledoors.co.uk](http://www.prosaledoors.co.uk)

# PRODUCT RANGE

## LH100 DUALCORE

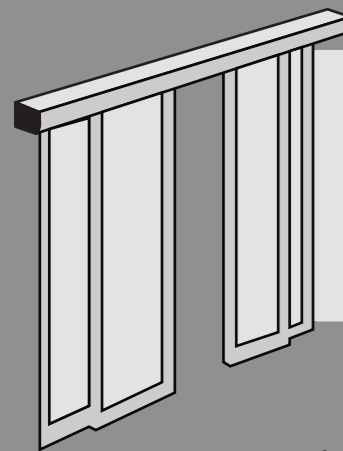

At 115mm tall the LH100 Dualcore still keeps with our design ethos of keeping things small, but practical. The LH100 Dualcore can cope with door weights of 100kgs each as a bi parter and 140kgs for a single.

## LH140 DUALCORE

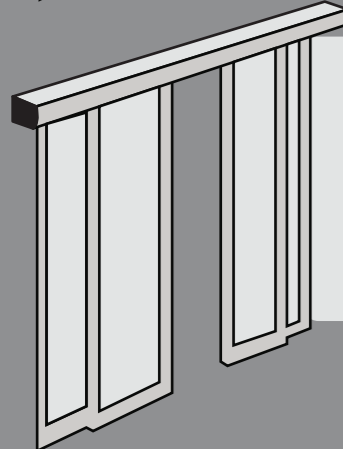

Still keeping with 115mm tall the LH140 Dualcore can cope with door weights of 140kgs each as a bi parter and 160kgs for a single. This mighty capacity is based on an upgraded motor and keeping with the profiles of the standard Dualcore.

## RD100 DUALCORE

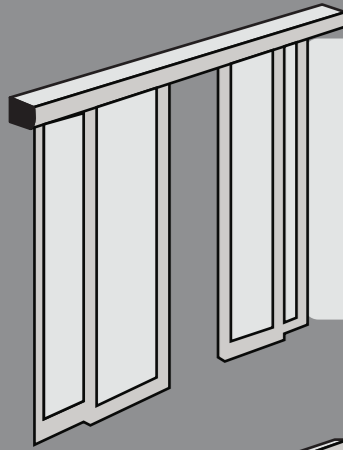

In line with the Dualcore identity this operator is manufactured to comply with the EN16005 Fire Exit regulations. The RD100 Dualcore has a complete backup device mirroring the normal operation (redundant system)

## TELESCOPICA

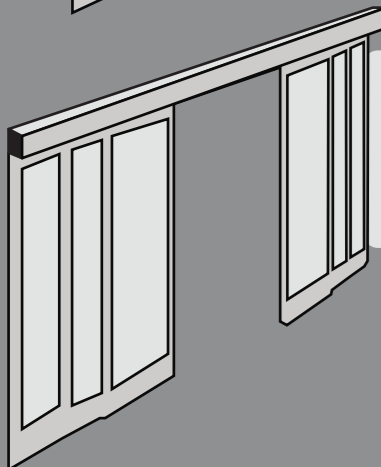

At 186mm high; The Telescopica will easily cope with weights of 120kgs for two leafs moving in one direction or 80kgs each for a four leafed, bi-parting entrance.

# TECHNICAL SPECIFICATIONS

MODEL	WINGS	MAX. WEIGHT	CLEAR PASSAGE WIDTH	POWER CONSUMPTION	SERVICE
LH100 DUALCORE	1	140 Kg	700÷3000 mm	150 W	Continuous
LH100 DUALCORE	2	2 X 100 Kg	800÷3000 mm	150 W	Continuous
LH140 DUALCORE	1	160 Kg	700÷3000 mm	180 W	Continuous
LH140 DUALCORE	2	2 X 140 Kg	800÷3000 mm	180 W	Continuous
RD100 DUALCORE	1	100 Kg	800÷3000 mm	180 W	Continuous
RD100 DUALCORE	2	2 X 100 Kg	900÷3000 mm	180 W	Continuous
TELESCOPICA	2	2 X 120 Kg	450÷3000 mm	180 W	Continuous
TELESCOPICA	4	4 X 80 Kg	450÷3000 mm	180 W	Continuous

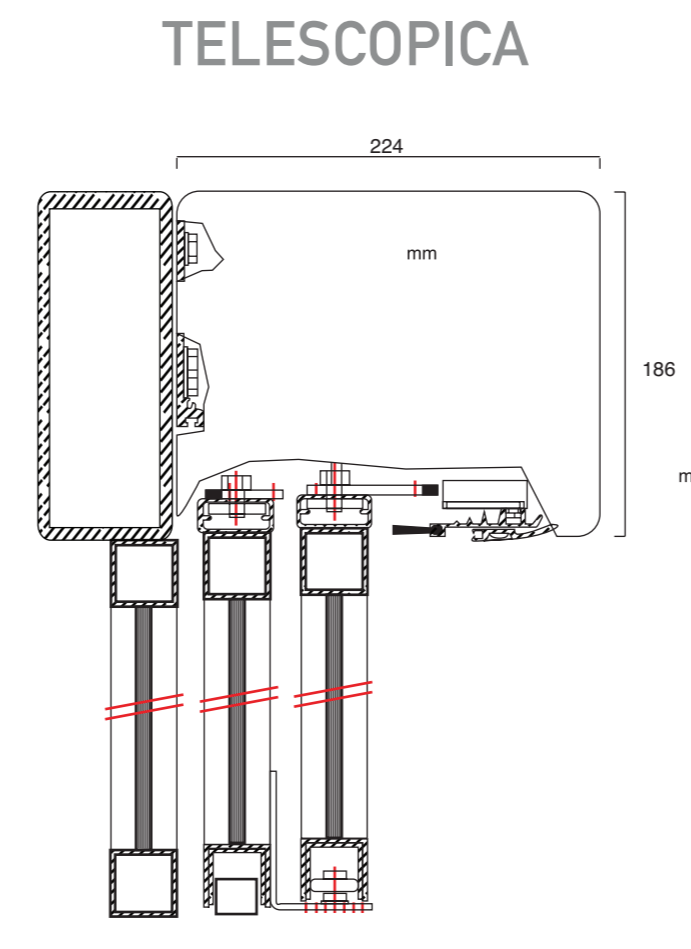
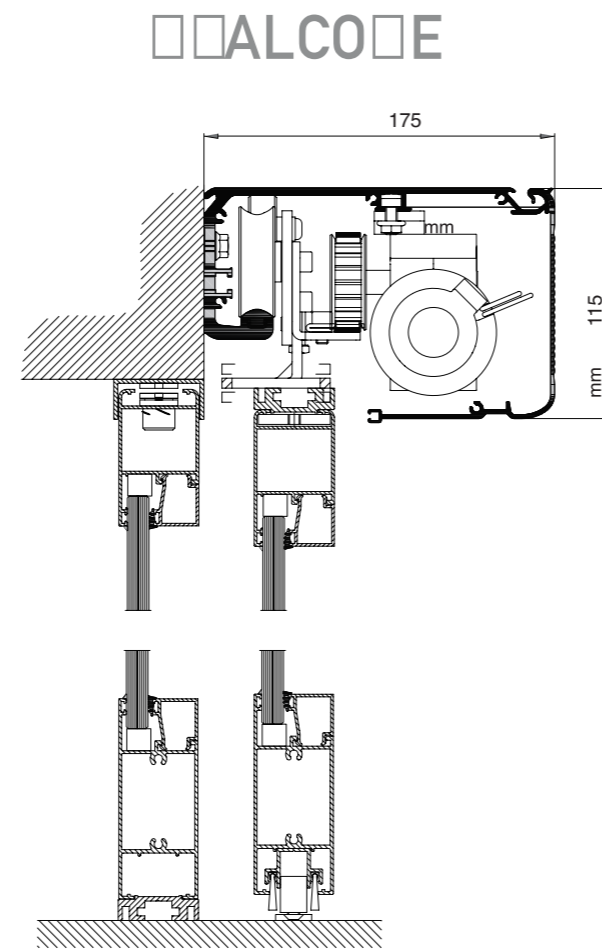

To calculate the height of the door:  
 Take the finished floor level (or top of threshold if being fitted) to the underneath of the transom.  
 This is the door height without our door adapter fitted. We lift the door 7mm when fitting to give clearance at the bottom.

# ACCESSORIES

## SELECTORS

Basic Selector



Advanced Selector



Lockable Selector



## SENSORS

Activation Sensor



In Head Activation Sensor



Side Screen Safety Sensor

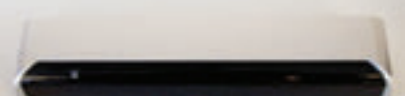

## TRIGGER DEVICES

Pushpad



Morning Entry Keyswitch



Handheld Push Button

